

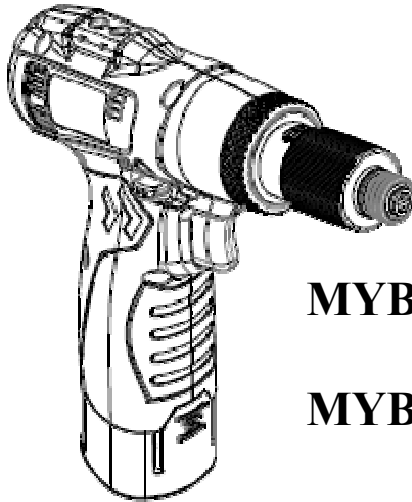

**Automatic Industrial Cordless Brushless
Power Torque Screwdrivers Series
OPERATION AND MAINTENANCE MANUAL**



MYBT-HD0320F

MYBT-HD0830

MYBT-HD1545

MYBT-HD2060

Rechargeable-TYPE Automatic Brushless Series

SAING EI CORP.

<https://www.mytorqtools.com>



Y2F227A-1E-003

Before you use the Cordless Screwdriver for the first time, it is essential to read and understand the manual completely (including the spare parts view). The term “Cordless Screwdriver” in all of the warning listed below refers to your main operated appliance.

Icon Instructions

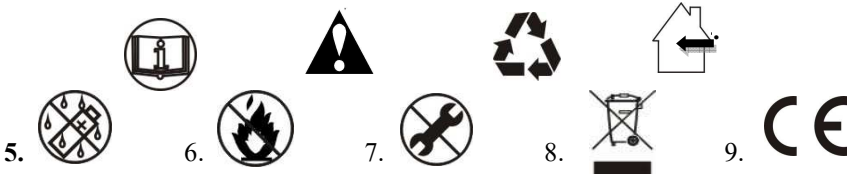

- 1. Read instruction manual.
- 2. Observe caution and safety notes.
- 3. Recyclable.
- 4. For indoor use only.
- 5. Do not expose to wet or rain conditions.
- 6. Do not operate in an explosive atmosphere.
- 7. Do not disassemble.
- 8. Forbid to throw away.
- 9. CE certification.

Accessories

Item	Quantity	Unit
Manual	1	PCS
Waist hook	1	PCS
Screw M3*0.5P*8L	1	PCS
Bit	2	PCS
Guarantee Card	1	PCS

Warning

Read all instructions and make sure the appearance of the device has no damage before you use it. Failure to follow all instructions listed below may result in electric shock fire and/or serious injury.

1. Keep the working area nice and clean.
 - 1.1 Mess and dark areas may cause of accidents.
 - 1.2 Keep the device away from rain or moisture to decrease the risk of electric shock or short-circuiting occurred.
2. Be alert to workplace safety
 - 2.1 Use the device under a well lit and clean environment.
 - 2.2 Keep children and other people away unless the person has been assigned for the task to avoid the danger of injury.
 - 2.3 Do not play around while the tool is being used to avoid the danger of distractions.
 - 2.4 Do not work with the device in potentially explosive environments in which there are inflammable liquids, gases or dusts. Electrical power tools create sparks, which can ignite dusts or fumes.
 - 2.5 Do not use the device if you are tired or under the influence of drugs, alcohol or medication.
3. When the devices are not being used, store them in a safe place.
4. Use a suitable device for the job will be safer at work and have a better result.
5. Always use a screwdriver that is intended for the task you are undertaking. Do not overload or use it improperly such as drilling or tapping.
6. Dress properly. Do not wear loose clothing or jewels while operating the tool to avoid the danger of trapping.
7. By using the device correctly, make sure to hold it firmly with two hands in place before starting the trigger.
8. When using the electrical power tool, take into account the auxiliary handle or waist hook is advantage of working conditions. On the contrary, the purposes of the waist hook is convenient to put the device away and easier to keep it out of reach of children.
9. Look after either the device or the battery carefully and have any damaged parts repaired by an authorized or qualified shop. Always keep the tool nice and clean; pay attention on the machine grease which might ruin the tool.
10. Disconnect the plug from the power source after the charger has been used.
11. Take apart the battery from the device when it is not being used.
12. Use only the accessories that are detailed in the operating instructions. The use of others which are not recommended in the operating instructions may affect the functioning of the device. It could lead to an increased risk of personal injury as well.
13. Remain alert at all times and watch what you are doing during proceeding. Before operation, always check every part is in good condition and move freely in order to function properly.
14. This device only applies for metal screw bits designated with their dimensions and their shape. Do not recommend to countersink or force of loading on any material such as plastic and wooden.
15. The device does not apply for elastic or tensile load with washer on.
16. To prevent parts in gearbox from damage, replace the grease at least once for every year.
17. It is necessary for the operators to read and follow up all the operating instructions in this manual. **SAING EI** is not responsible for any personal injury that might cause of disobeying the safety advice.
18. Use a safety device. Wear protective earmuffs to reduce personal injury

19.

Noise:

The typical A-weighted noise level acc. To EN62841-2-2.

Sound pressure level(LpA): 53.6 dB(A)

Sound power level(LwA): 64.6 dB(A)

Vibration:

The vibration total value acc. EN62841-2-2.

Vibration emission value ah (m/s²): 0.17 m/s²

Uncertainty K (m/s²): 0.02 m/s

Cordless Tool Protections

- Over electric current protection
- Thermal Protector
- Slow rotation protection
- Battery Identification
- Prevent from low power
- Stall protection
- Reverse control protection
- Sleep & power saving mode

Warning

-  **Do not attempt to repair or disassemble this cordless screwdriver, the warranty will be considered void.**
1. To maintain the tool, make sure to remove the battery pack before maintaining or repairing the device by a qualified technician.
 2. Do not attempt to disassemble or reassemble the device it may result in poor performance or danger of injury; the warranty applies only to initial package.
 3. Do not repair the device with other than genuine **SAING EI** replacement parts may result in poor performance or danger of injury, the warranty will be considered void.
 4. temperature between $0^{\circ} \text{C} \sim 35^{\circ} \text{C}$ would be an ideal condition of carrying out the tasks on the device.

Operating Instructions

1. Charge the battery in the charging station before first use to make sure operates at its highest capacity. To ensure operators against injuries, release the Forward/Reverse lever as arrow showing below into a center position to have trigger locked before start or disassemble the device.

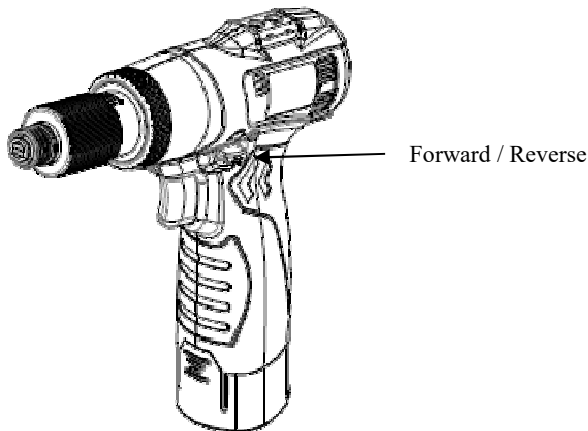

2. Follow below steps to correctly install & remove battery.

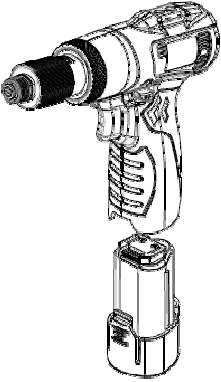
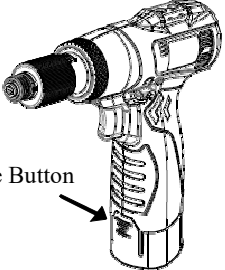
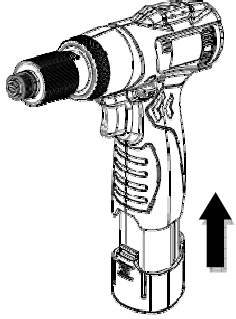
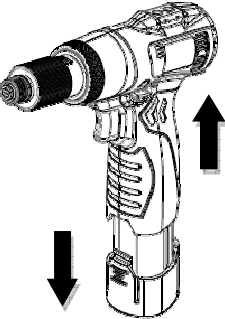
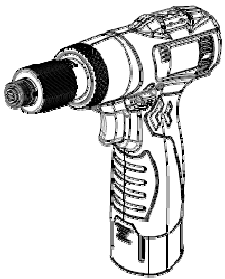
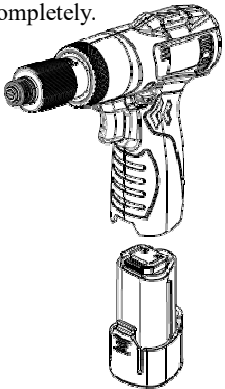
Insert Battery Steps	Remove Battery Steps
<p>(1) Take screwdriver and battery.</p> 	<p>(1) Press the release button and take it out of the Device.</p>  <p>Battery Release Button</p>
<p>(2) Insert the rechargeable battery into the device follow by the arrow as showing.</p> 	<p>(2) Follow the arrow direction.</p> 
<p>(3) Assembled completely.</p> 	<p>(3) Removed completely.</p> 

Function / Operating Introduction

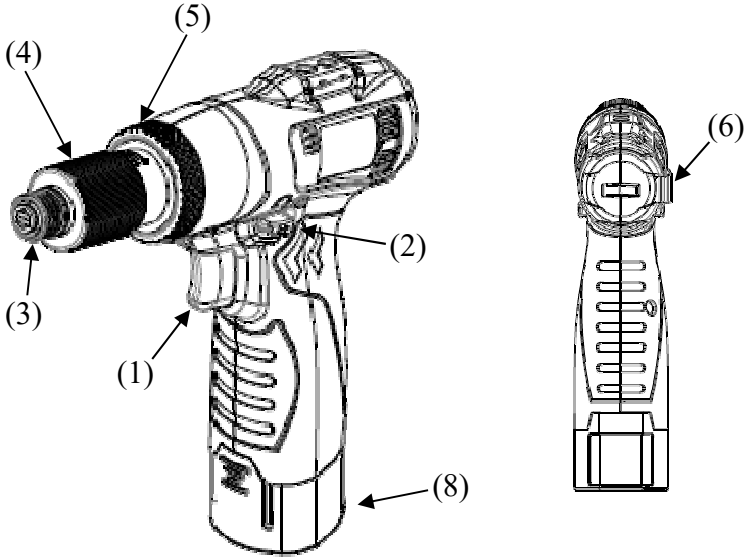

Function Name Table

No.	Description	No.	Description
(1)	Trigger Switch	(5)	Torque Fixing Ring/Coupler
(2)	Forward/Reverse Lever	(6)	S Waist Hook
(3)	Bit Sleeve	(7)	OK/NG/Power/Hi & Lo Indicating Light
(4)	Torque Fixing Ring	(8)	battery

Manual / Function

1. Full Auto Shut-Off Screwdriver

It stops automatically when the screw has been tightened up and reached the set-up torque level. The device will not cause damage of task since no continue running after screws are tightened.

(1) Trigger Switch

The LED lights are on when the trigger switch has been pressed about one-third down, and then the screwdriver starts functioning when the switch trigger has been pressed half way down; on the contrary, it stops when the screw has been tightened up or the trigger has been released.

(2) Forward / Reverse Switch

2-1 When the switch turn to the right as arrow indicates, the screwdriver will be clock-wise Screwing to tighten things up; Vice versa, left switch means to release the screw. As the diagram showing, always set the switch to neutral position when the screwdriver is not being used.

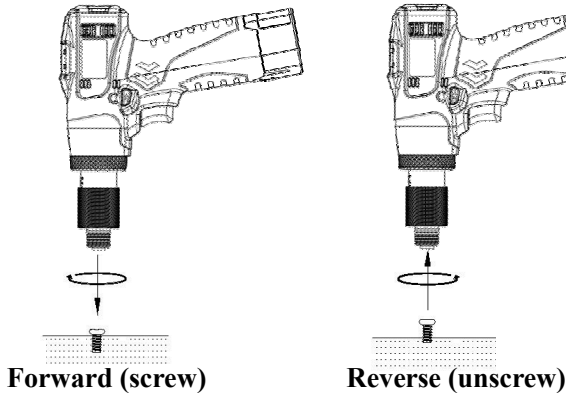

2-2 Hi/Lo: to change the speed of rechargeable screwdriver, push Forward/Reverse lever to the middle position, release the switch for about 0.5 second and press trigger switch for 5 seconds, then there will be a short beep sound to adjust the position.

1) It represents Hi position when the power/Hi &Lo indicating light is off.

2) It represents Lo position when the power/Hi &Lo blue indicating light is lit constantly.

2-3 Hi/Lo Switch: When the rotating speed needs to be changed, set up the switch to Hi for the fastest rotation, and setup the switch to Lo for slowest rotation. It's possible that the uncompleted shut-off occurs when the switch is setup to Lo and the presetting torque is more than 50% of torque range. Please refer to the following table.

Lo Switch Shut-off	MYBT-HD0320F	MYBT-HD0830	MYBT-HD1545
OK	1 (N.m) ↓	1.5 (N.m) ↓	2.25 (N.m) ↓
NG	1 (N.m) ↑	1.5 (N.m) ↑	2.25 (N.m) ↑

(3) Bit Sleeve

To Switch the bit and compatibility, pull the head of the type B screwdriver, and install the bit according to the diagram below, and push it in following the arrow indicated on the diagram.

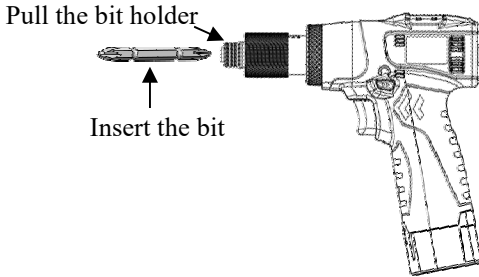

(4) Torque Adjustment Ring:

Turn torque adjust ring counter clock wise to increase torque output, on the other hand decrease torque output by turning torque adjust ring clock wise. 0 printed on the torque adjust ring indicates the minimum torque for setting and 8 for the maximum torque setting. Do not turn torque adjust ring lower than 0 or higher than 8 to avoid torque adjust ring getting stuck with clutch.

(5) Torque Fixing Ring/Coupler

5-1 Torque Fixing Ring: To prevent torque to be adjusted, fixed upside-underside housing and clutch.

5-2 Coupler: Fixed upside-underside housing and clutch.

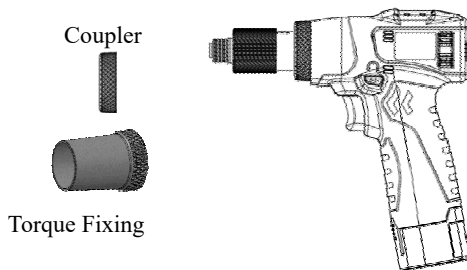

(6) S Waist Hook

The waist hook allows users to carry the device easily by attaching it to their work belt.

(7) OK/NG/Power/Hi& Lo Indicating Light Explanation

Protection Explanation: The indicating LEDs will show Hi/Lo when push Forward/Reverse lever to the middle position. Speed can't be adjusted when temperature protection is activated. Please wait until temperature protection is deactivated.

Signal Indicator Sound Judgment		Start		Release switch to stop running		Screw reaches set torque		Screw NG		Current Protection	
		Hi	Lo	Hi	Lo	Hi	Lo	Hi	Lo	Hi	Lo
Signal Indicator 	Running	No lights	No lights	red	red	green	green	red	red	red	red
	Stop	No lights	blue	No lights	blue	No lights	blue	No lights	blue	No lights	blue
Beep Sound		No		1 short		NO		3 short		6 short	

7-1 Low Battery Protection: When it reaches a low battery, the red indicating light flashes and beep sounds continuously until the battery is no power and screwdriver is stops working, the indicating light flashes ON/OFF and beep sounds 2 short 1 long. It won't detect the battery power when the motor and PCB temperature protection are activated.

7-2 Temperature Protection: The red indicating light flashes and beep sounds 9 times.

7-3 Sleep & Power Saving Mode: It will enter sleep mode when the screwdriver stopped for about 5 seconds, press the lever can wake up sleep. The power will be cut off when sleep more than 24 seconds, press the switch can restore power.

(8) battery

Other Cautions

1. The best condition of using the tool is under 8 hours a day, do not overloaded. cording to operating frequency and torque loaded; we suggest adding lubricating oils in clutch per 3-6 months, and kindly contact with distributor when product's maintenance.
2. Do not attempt to repair or disassemble this cordless screwdriver without authorization. Always have the device serviced by assigned factory or qualified person in order to have the warranty effective continually.
3. **SAING EI** is not responsible for any poor performance or damage caused by customers own modification of the tool.
4. It is necessary for the management to have every operator to read and follow all instructions in this manual. Do not attempt to repair or disassemble this cordless screwdriver themselves.
5. Chemicals, Acetone, Benzene, Alcohol, Thinner, Ketone, trichloroethylene, etc shall not be in contact with the surface of the screwdriver in order to prevent chemical damage.
6. Please follow instruction carefully and do not drop or shock the screwdriver.
7. This is an external torque adjustment screwdriver, 0 on the torque adjust ring stands for minimum torque and 8 for maximum torque. The rated operation time is 1 second / 3seconds (ON / OFF). Appropriate fastening frequency is 15 fasteners in each minute. Overrunning may damage motor due to overheat. Proper amount of screwdriver resting is recommended to prevent motor overheating.

Slow speed Duty Cycle Conversion (for reference)

Based on 1000 rpm, 1 second ON/3 seconds OFF. For example, the duty cycle for 350rpm, $1000-350=650$, $650/1000\%=65\%$

ON= $1*1.65= 1.65$, OFF = $3*1.65 =4.95$ (rounded value) =2 seconds ON / 5 seconds OFF

This tool is intended for a duty cycle of 2.0 sec on, 5.0 sec off.

Slow speed (rpm)	operation frequency	Slow speed (rpm)	operation frequency	Slow speed (rpm)	operation frequency	Slow speed (rpm)	operation frequency
900	1.0 ON 3.0 OFF	650	1.0 ON 3.0 OFF	450	2.0 ON 5.0 OFF	250	2.0 ON 5.0 OFF
850	1.0 ON 3.0 OFF	600	1.0 ON 3.0 OFF	400	2.0 ON 5.0 OFF	200	2.0 ON 5.0 OFF
800	1.0 ON 3.0 OFF	550	2.0 ON 5.0 OFF	350	2.0 ON 5.0 OFF	150	2.0 ON 5.0 OFF
750	1.0 ON 3.0 OFF	500	2.0 ON 5.0 OFF	300	2.0 ON 5.0 OFF	100	2.0 ON 5.0 OFF
700	1.0 ON 3.0 OFF						

8. Not allow to turn the Hi/Lo switch during operation in order to cause system malt-function.
9. The device will not be able to function again once the OK/NG indicator/signal is not turn off yet.
10. When adjusting the torque, for safety purpose should stop the screwdriver completely and set the switch to neutral position. It could prevent the user from turning the tool on accidentally.
11. During operation, the switch has been changed accidentally that the device will enable its self-protecting mode which is power off. Re-start the tool when this happens.
12. Each operational torque setting, using time and frequency may result in different level of wear and tear, at higher torque setting and use extensively could accelerate the wearing down of tool. After one month, the torque is getting reduce gradually at the rate of 2~3% or 3~5 % (max torque). The longer use of the device, torque reduction will become stable and the users could measure the torque by a tester on a regular time schedule to check if the torque power still meets the criteria.
13. The torque range of MYBT-HD0320F/MYBT-HD0830/MYBT-HD1545 must be measured by the **SAING EI** torque meter KTM-150.
14. **SAING EI** cordless screwdriver torque output is generated by clutch mechanism, and it is applicable to ISO 6789.

Specifications

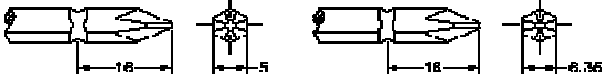
MODEL		HD0320F	HD0830	HD1545	HD2060
INPUT VOLTAGE(DC)		DC 10.8V			
TORQUE (N.m)	hard joints	0.5-2	0.8~3	1.5-4.5	2-6
	soft joints 80%↓	0.5-1.6	0.8-2.4	1.5-3.6	2-4.8
Torque accuracy (%)		±3%			
Torque adjustment		Stepless			
Duty cycle		1.0s ON 3.0s OFF			
Unloaded Speed (min ⁻¹)±10%	HI	2700	1400	800	650
	LO	1900	1000	550	450
Screw size (mm)	Machine screw	2.3~3.5	2.6~4.0	4.0~5.0	4.0~5.0
Weight (kg)		0.7kg (w/o battery)			
Length (mm)		188.5*156.5 (L*H , w/o battery)			
Model of Torque Fixing Ring		KC-28A			
Applicable battery		SKC-LB1025S			
Applicable charger station		MYCS-ID50N			
Applicable Bit type					

HEX 5mm,

HEX 6.35mm

* 1N.m=10.2Kgf.cm 1N.m=8.85Lbf.in

Bits Code ~ B: Hex 6.35mm

Accessory ~ Bit no. : No.2 Bit use in dia 3.0~4.0mm screw

HD0320F	with BIT	1# & 2#	1 Pcs. Each.
HD0830/MYTB-HD1545	with BIT	2#	2 Pcs.

CAUTION 
SAVE THE INSTRUCTIONS
DO NOT DESTROY

Torque Adjustment Operation

To adjust the torque on these screwdrivers. Proceed as follows :

1. Determine the torque output of the tool by checking a tightened fastener with a torque wrench.
2. Increase or decrease the torque by rotating torque Adjusting Ring. Rotating the Ring clockwise to a higher number on the torque Scale increase torque output while rotating the Ring counterclockwise to a lower number decreases the torque output.
3. Check the adjustment with a torque wrench. A number of factors will affect torque output from one job to another. Final torque adjustment should be made at the job through a of series of gradual increase. Always start below the desired torque and work upward.
4. Adjust the bit torque by changing the driving in length of the adjust ring at the end.
5. The relationship between torque scale and bit torque is as shown Ring, in the torque diagram. The figures of torque scale do not indicate bit torque values. However, the clamping torque of screw itself is different form type, size, material of the screw and the material of its mating part. Use it as standard to obtain an appropriate clamping torque.
6. The (Return torque method) in which once-clamped screw is returned with torque wrench or the like is available as one of torque control methods, however, note that the measured values by the return torque method generally appear in 10%~30% lower than the actually clamping torque.
7. The torque checker measures the torque of screwdriver. The clamping torque of screw itself is different from the clamped conditions. Understand the correlation between clamping torque values and the torque checker values perform the torque control properly.

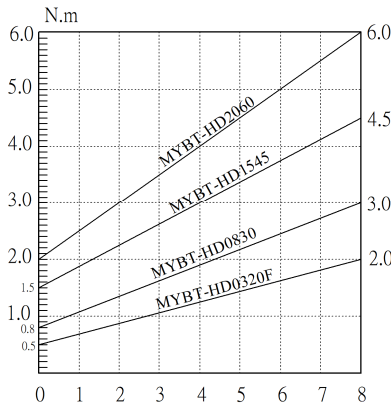

CAUTION

1. In reverse rotation, the clutch is turned off when a screw is tightened at large torque, set same or higher torque to unscrew.
2. The number from zero to eight on the Torque Scale are reference number only and not an indication of actual torque output.
3. Please refer to SAING EI website <http://www.mytorqtools.com> for the detail component list.

Our company reserves the right to modify the product without prior